

幌加内町役場機構図

(令和5年4月1日現在)

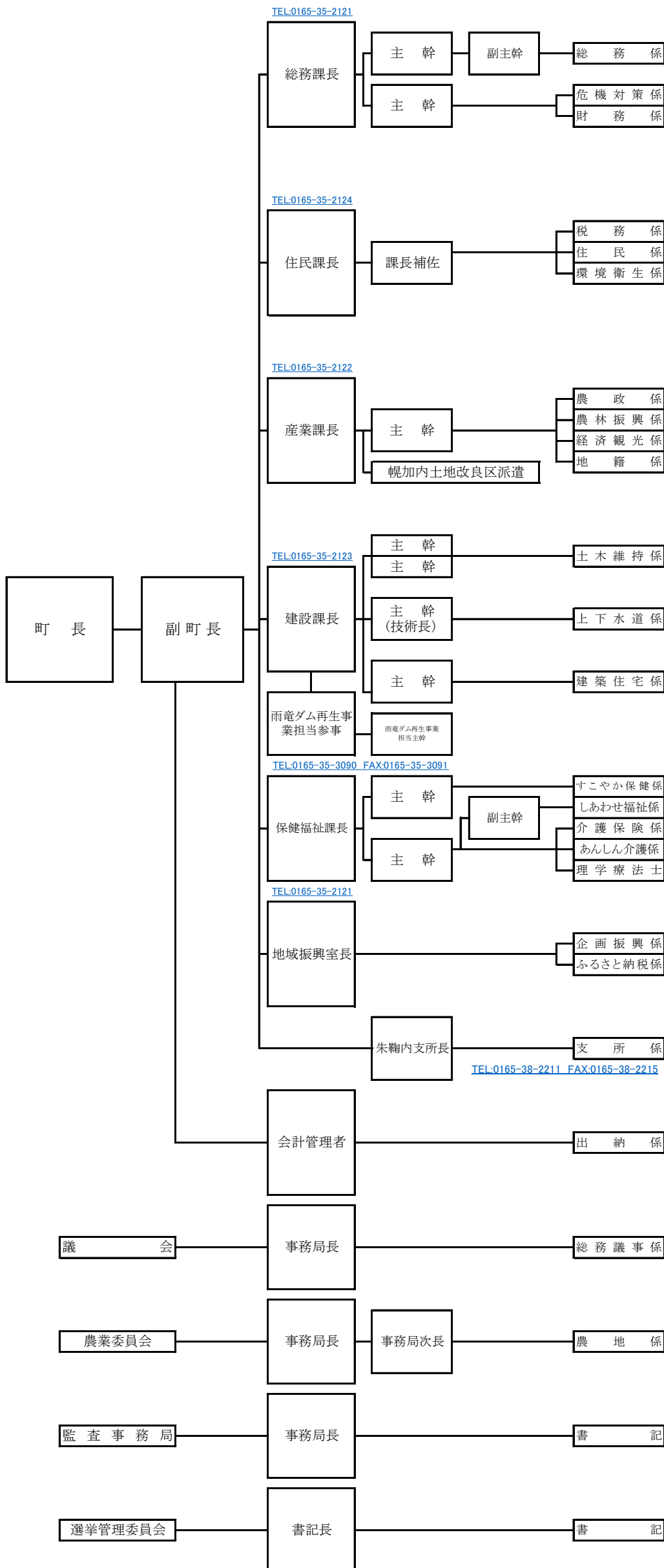

住 所：〒074-0492 兩竜郡幌加内町字幌加内4699番地
 電 話：(代表)0165-35-2121 FAX：0165-35-2127
 ホームページ：http://www.town.horokanai.hokkaido.jp/
 E-mail:horol@mb.infosnow.ne.jp(代表)

TEL:0165-35-2177 FAX:0165-36-2100

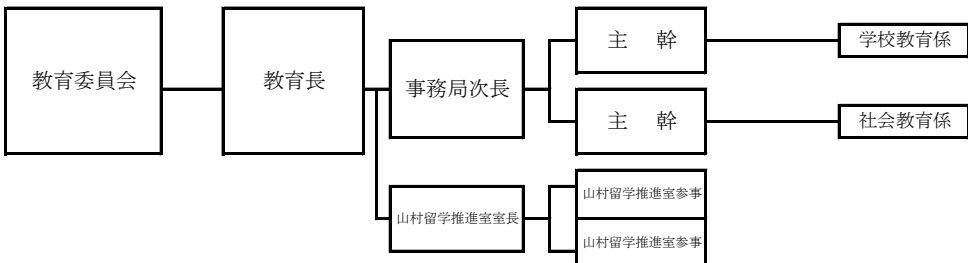

中央公民館

館長

TEL:0165-35-2177 FAX:0165-36-2100

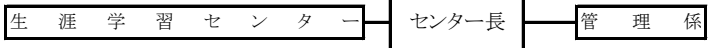

TEL:0165-35-2432 FAX:0165-35-2438

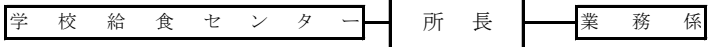

TEL:0165-35-2405 FAX:0165-35-3477



TEL:0165-35-2321 FAX:0165-35-2323

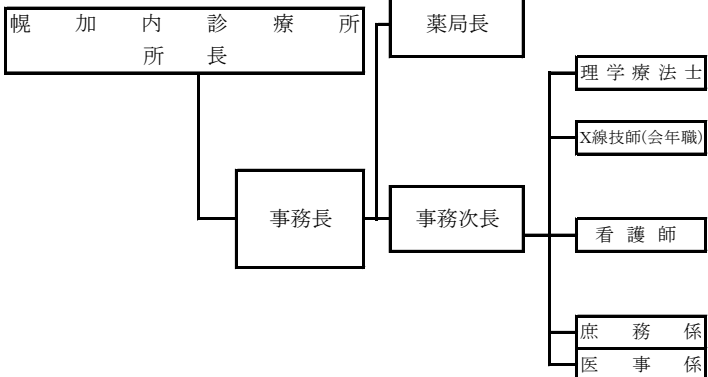

TEL:0165-38-2213

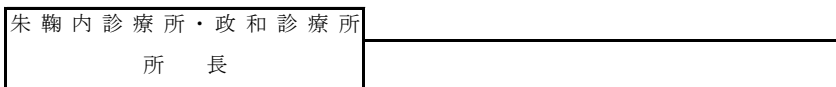

保健福祉総合センター
センター長

TEL:0165-35-3090 FAX:0165-35-3091

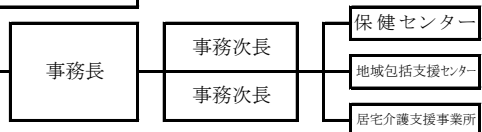

TEL:0165-35-2246 FAX:0165-35-2248

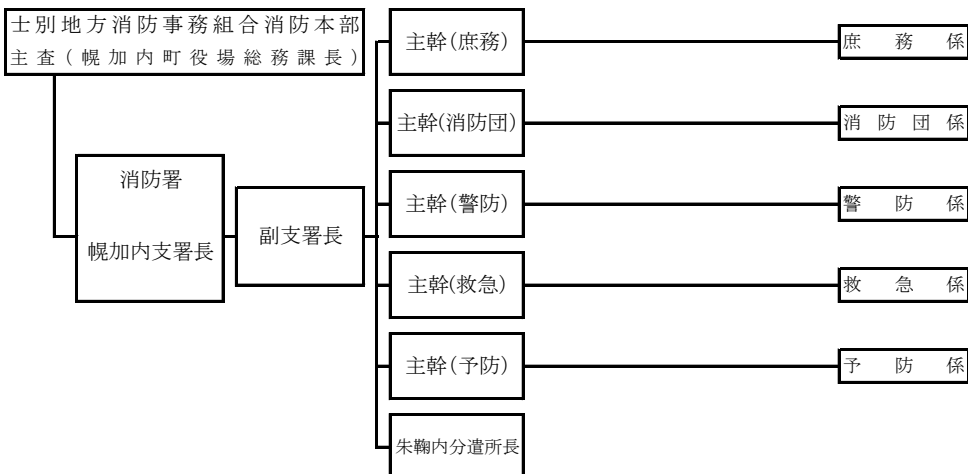

TEL:0165-35-2604 FAX:0165-36-2663

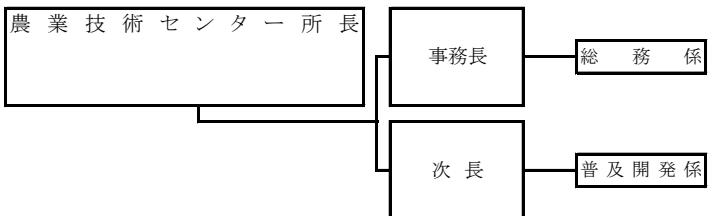

TEL:0165-35-2713

